

REV	DESCRIPTION	BY	CHK	DATE	ECN / MPS
A	ENGINEERING RELEASE	JGS	AH	2/12/05	M63978

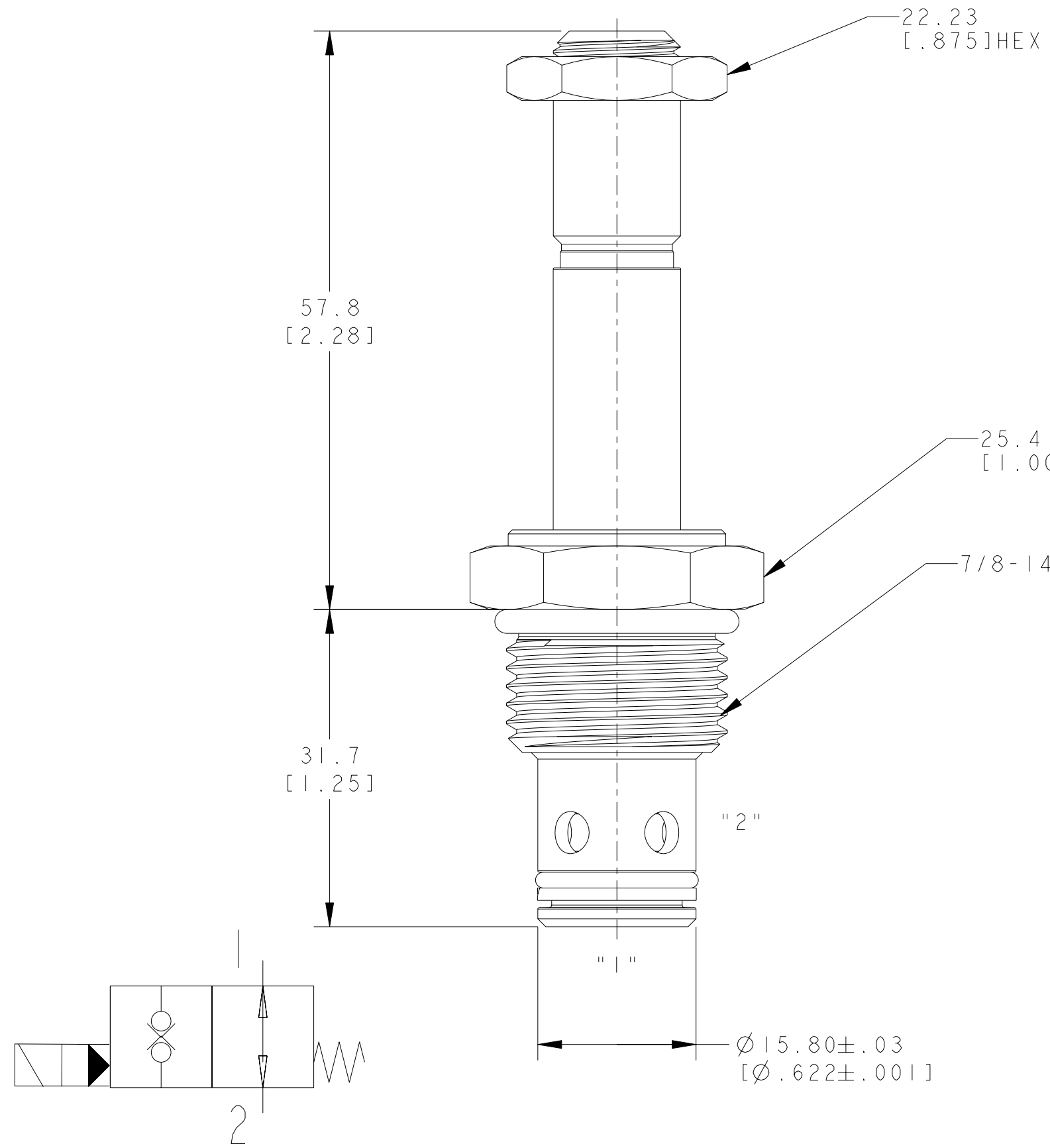

NOTE:

- 1 USE VALVE CAVITY C-10-2
- 2 TORQUE INTO CAVITY:  
ALUMINUM CAVITY: 47-54 N.m[35-40 lbf.ft]  
STEEL CAVITY: 68-75 N.m[50-55 lbf.ft]
- 3 NET WEIGHT :0.18KG[.39 lb]

MC  
DISTRIBUTION CODE(S)

UNLESS OTHERWISE SPECIFIED ALL DIMENSIONS ARE IN INCHES <input type="checkbox"/> MILLIMETERS (INCHES) <input checked="" type="checkbox"/>	DRAWING BASED ON ANSI Y14.5M-1982	
	THE REPRODUCTION, DISTRIBUTION, AND UTILIZATION OF THIS DOCUMENT, AS WELL AS THE COMMUNICATION OF ITS CONTENTS TO OTHERS WITHOUT EXPLICIT AUTHORIZATION IS PROHIBITED. OFFENDERS WILL BE HELD LIABLE FOR THE PAYMENT OF DAMAGES. ALL RIGHTS RESERVED IN THE EVENT OF THE GRANT OF A PATENT, UTILITY MODEL, OR DESIGN. (PER ISO 16016)	
TOLERANCES .X ± .XX ± .XXX ± ∠ ±	DRAWN JGS BY/DATE 6/19/03	MATERIAL/HEAT TREAT \
UNSPECIFIED RADII ARE: ----	CHECKED AH BY/DATE 3/10/05	TITLE SOLENOID VALVE INSTALLATION
UNSPECIFIED DRAFT ANGLES ARE: -----°	ENGRG BY/DATE \	NUMBER A-2416-091
B SIZE	THIRD ANGLE PROJECTION DO NOT SCALE	SCALE 2/1 SHEET 1 OF 1

